

Original scientific article
UDK 519.85:[622.24:550.822
DOI: 10.7251/afts.2022.1426.001N
COBISS.RS-ID 136082689

APPLICATION OF HYBRID SFLA AND ACO ALGORITHM TO OMEGA PLATE FOR DRILLING PROCESS PLANNING AND COST MANAGEMENT

Nasir Mehmood¹, Muhammad Umer¹, Umer Asgher²

¹*Business and Engineering Management Department/Sir Syed CASE Institute of Technology, Islamabad, Pakistan, e.mail: mahiahmadb2@gmail.com*

²*National Center of Artificial Intelligence (NCAI), School of Mechanical and Manufacturing Engineering (SMME), National University of Sciences and Technology (NUST), Islamabad, 44000, Pakistan*

ABSTRACT

Tool traveling and tool switching time constitute almost seventy percent (70%) of the total time consumed in drilling process. This fact that 70% of the total time is nonproductive and does not add any value to the job, grabs attention of the researchers and the industrialist for optimization. A literature on drilling process revealed that very few studies have been done on hybridization of metaheuristics for optimization of tool travel time. This research gap is the motivation of the present study. In this study, two metaheuristic approaches – the shuffled frog leaping algorithm (SFLA) and ant colony optimization (ACO) were hybridized. With respect to hybridization of SFLA and ACO, this study signifies its originality and novelty in which main objective is to minimize the tool travel time. The literature review also revealed that the shortest path generated through commercially available software is not optimal all the time.

This aspect emphasizes the application of metaheuristic algorithms on the real-world industrial problems. In this study, the proposed hybrid algorithm was applied to drilling of omega plate which is used in automobile manufacturing industry. The results of the proposed hybrid algorithm were compared with those of manual drilling path and software generated path. The results obtained through proposed hybrid algorithm were improved by 11.1% when compared to results of manual drilling path. The results of proposed algorithm were also better than results of commercial software Creo 6.0 and Siemens NX by 5.9% each.

This showed that hybrid algorithm outperformed the commercially available software. This not only validates the efficacy of proposed hybrid algorithm, but also indicates the significance of the metaheuristic algorithm applications in industrial optimization problems.

Keywords: manufacturing management, optimization, industrial management, artificial intelligence, engineering techniques

INTRODUCTION

Drilling is the machining process in which a drill bit creates a circular hole in the work piece. It is such a process which is used in almost all manufacturing industries which indicates its importance. Drilling

process comprises of drilling the hole, tool switching and moving the drill bit to different hole locations.

The tool switching and tool traveling to different holes constitute 70% of the drilling time [1]. It is pertinent to mention that this 70% of the drilling time is nonproductive as it does not add any value to the work piece because it does not contribute to actual drilling of the holes. This aspect of drilling process has attracted the attention of researchers and practitioners for minimization of nonproductive time. In this paper, the main aim is to minimize the tool travelling time for the drilling of omega plate.

Manufacturers and industrialists are always hard pressed for meeting the orders in due time. As minimization of the tool travel time helps in reduction of manufacturing time, therefore it reduces the lead time and helps manufacturers to meet the orders in time. Other important aspect is the manufacturing cost which can also be reduced as minimization of tool travel also reduces overhead costs. Thus, by reducing the overhead costs, the manufacturing cost of the products can be reduced which provides the competitive advantage.

DRILLING PROBLEMS BASED ON LITERATURE REVIEW

As per the job patterns, drilling problems can be classified as rectangular, circular, multi-surface and path constraint problems. In view of the tool requirements, drilling problems can be grouped into single-tool hole drilling problems (ST), multi-tool hole drilling problems (MT), multi-tool hole drilling with precedent constraints (MTpc), and multi-tool hole drilling with sequence-dependent drilling times (MTseq). Furthermore, different modeling approaches can be applicable to drilling problem keeping in view its nature. The ST drilling problem is modeled as a symmetric traveling salesman problem (TSP). The MT drilling problem is modeled as an asymmetric TSP. MTpc is modeled as the precedent constraint TSP (PCTSP).

The relatively complex problem MTseq is modeled as a precedent constraint generalized TSP (PCGTSP). Costs in drilling problems are considered in terms of the actual drilling time, tool switch time and tool travel time from one hole to other holes. For ST, MT, and MTpc, both the tool switch time and tool travel time must be minimized as an objective function. For MTseq, the drilling cost is also considered. Traveling costs are generally set as a function of the distance between drill holes. Distances involved in drilling problems are of following three types:

$$d_{euclidean} = \sqrt{(x_1 - x_2)^2 + (y_1 - y_2)^2} \quad (1)$$

$$d_{rectilinear} = |x_1 - x_2| + |y_1 - y_2| \quad (2)$$

$$d_{chebyshev} = \max(|x_1 - x_2|, |y_1 - y_2|) \quad (3)$$

METHODOLOGY

Drilling is either done through manual drilling machines or computerized numerically controlled (CNC) machines. In case of manual drilling machines, the drilling tool path depends upon the technician's choice. In case of CNC, technician provides the path to CNC either through G codes or through the commercially available software. These software optimize the drilling tool path and it is believed in the industry that the path provided by the software is always optimal. However, literature reveals that in many cases, when results of commercially available software are compared with those of metaheuristic approaches, it is found that results of metaheuristic approach are better.

In [2] parallel implementation of ACO has been presented to improve and optimize the sequence of operations for a PCB. The results achieved are compared with the results of MasterCAM and it is found that drilling time achieved by ACO is less than the time taken by MasterCAM in all case studies. ACO metaheuristic was also applied in [3] for optimization of circular pattern drilling problems. ACO results are compared with the results of MasterCAM and the improvement in the

results achieved by ACO is around 62.27%. In [4] GA is used for optimization of drilling tool path optimization problems.

The results obtained from GA are compared with commercially available software ArtCAM and it is found that the results of GA are much better and improved as compared to results of ArtCAM.

In [5] a circular pattern drilling holes problem has been attacked using GA. The results achieved are compared with commercially available CAM software like WinCAM, CAMConcept and Catia V5. It has been seen that though these software have module of tool path optimization but GA provides more favorable and closer results to optimum.

In [6] cncKad Program is used to find the shortest path for drilling. The results are compared with already established results in the literature by using ACO and GA. It is found that the solution ACO gives is better than G codes produced through the commercially available software cncKad.

In [7] GA is applied to a work piece having 28 holes to be drilled. The results of GA are compared with the results of CAM system, Autodesk Inventor. The tool path optimization results show that performance of GA is better than Autodesk Inventor which is commercially available.

In [8] Discrete Teaching Learning Based Optimization (DTLBO) is applied for sequencing the holes and optimizing the tool travel time. The problem solved with DTLBO is compared with commercially available software CAMotics. The results showed the DTLBO is better than CAMotics.

In [9] GA is used for the optimization of drilling tool path. The algorithm is employed on concentric circular holes drilling problem. The results achieved through GA are compared with those of commercially available software NCplot v2.34. The total length obtained through NCplot v2.34 is 13959mm where as by GA it is obtained as 1945mm. Similar types of results are obtained for PCB problem. The length of path from GA is 1902mm where as from NCplot v2.34 it is 4361mm. The improvement is significant when metaheuristic approach is used.

This indicates that tool path provided by commercially available software is not always optimal. It can also be inferred that use of metaheuristic approach for optimization of drilling tool path is very useful and it can improve the accuracy of the results. This inference from the literature encourages the employment of metaheuristic algorithms for the optimization of drilling tool path.

HYBRID SFLA AND ACO ALGORITHM

In this section, the basics of the SFLA, basics of ACO, and development of the proposed hybrid algorithm are presented.

a. Basics of SFLA

The SFLA is originated by Eusuff and Lansey which is a metaheuristic technique [10]. The SFLA uses a deterministic approach that provides guidance for a heuristic search and a random approach, which ensures the robustness of the algorithm. In SFLA, there are numerous frogs, which are referred to population. Each frog in the population is randomly generated. Frogs in the initial population are divided into a specific number of memplexes. These memplexes represent different cultures of frogs, and a local search is performed in each memplex.

Every frog in the memplex holds an idea that affects other frogs; hence, a mimetic evolution occurs in each memplex, which improves the results. These mimetic evolutions constitute a defined iterative process after which the frogs are shuffled among the memplexes in the same way as they were initially distributed in the memplexes from the randomly generated population.

The iterative evolution for local search and shuffling for global optima is repeated for a predefined number until the desired optimized results are achieved [11,12]. SFLA can be applied to economic load dispatch problem [13], multi objective power flow problem [14], and project management [15].

b. Basics of ACO

ACO is inspired by the foraging behavior of ants. Ants find the shortest path between their nest and the food source through indirect communication with each other, which is called stigmergy. Dorigo et al coined the term ACO and proposed ACO algorithm in their PhD thesis [16]. ACO is an approximate, stochastic, and probabilistic technique that is most often used for discrete problems; however, it is also used for continuous problems.

It is a constructive procedure that iteratively builds and improves the solution. ACO employs swarm intelligence, which is based on the collective performance of the swarm rather than the individual performance. ACO algorithms can be applied to all kind of scheduling problems especially job shop scheduling and flexible job shop scheduling problems [17].

Initially, artificial ants are placed at randomly selected nodes. Each artificial ant uses the probability of moving to the next node and so on until the completion of the tour. The probability of an ant k located at node i moving to node j is given as

$$p_{ij}^k = \frac{[\tau_{ij}]^\alpha [\eta_{ij}]^\beta}{\sum_{l \in N_i^k} [\tau_{il}]^\alpha [\eta_{il}]^\beta}, \quad (4)$$

Where, τ_{ij} represents the number of pheromone trails, η_{ij} represents heuristic information, and α and β are parameters that control the pheromone quantity and heuristic information, respectively.

Development of proposed hybrid algorithm

In the proposed algorithm, it is assumed that P1 and P2 are the two most distant holes. After these holes are identified, the next step is to set one as P1 and the other as P2. There are two paths from P1 to P2. The remaining points are located on these two paths. After the selection of P1 and P2, the number of memeplexes is defined, which depend on the number of holes in the drilling problems. For a larger number of holes, more memeplexes are needed.

The basic structure of a memeplex is designed, and the remaining holes are allocated to the memeplexes. If the total number of holes (N) in the drilling problem is even, excluding P1 and P2, the remaining holes (P) are divided equally between the two paths available between P1 and P2. If the total number of holes (N) is odd, excluding P1 and P2, the remaining holes (P) are divided between two paths available between P1 and P2 such that one path has one more hole than the other. Thus, the defined memeplexes allow exploration of the search space.

After the numbers of holes in all the memeplexes are fixed, the sequence is set using ACO according to the probabilities based on the distances with the help of equation 4. The shortest distance has the maximum probability and vice versa. The total cost of the tour is calculated, and if the convergence criterion is satisfied, the algorithm stops; otherwise, the allocation of holes to the two paths is performed again using ACO until the desired results are obtained. The figure 1 as a flow chart explains the working of proposed hybrid algorithm.

APPLICATION OF HYBRID SFLA AND ACO ALGORITHM TO OMEGA PLATE

For optimization of drilling tool path problem, a problem from the automobile manufacturing industry has been selected. In this section, the problem definition, the results obtained through proposed algorithm and the comparison of results with those of commercially available software are presented.

a. Problem definition

In this section, the drilling of multi-holes in omega plate has been taken as a case study. The omega plate is used beneath the fifth wheel on the truck chassis. The figure 2 below shows the schematic diagram of the location of omega plate.

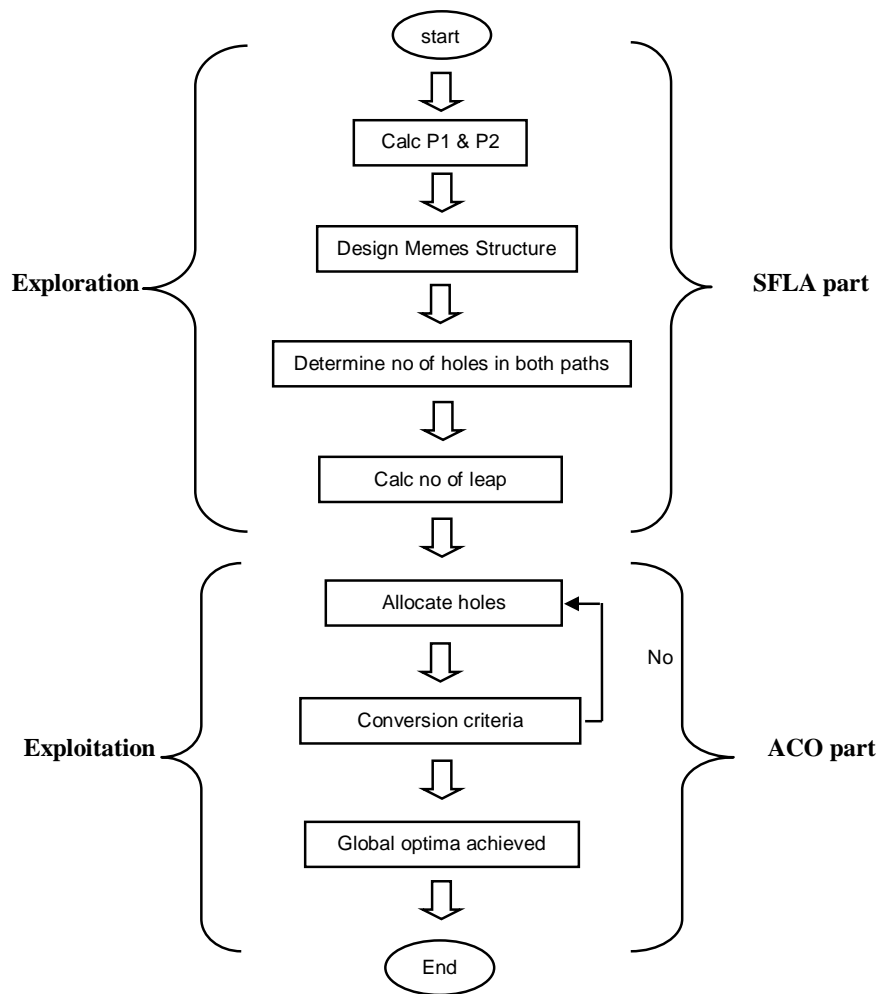

Figure 1. Flow diagram of proposed hybrid SFLA and ACO

APPLICATION OF HYBRID SFLA AND ACO ALGORITHM TO OMEGA PLATE

For optimization of drilling tool path problem, a problem from the automobile manufacturing industry has been selected. In this section, the problem definition, the results obtained through proposed algorithm and the comparison of results with those of commercially available software are presented.

a. Problem definition

In this section, the drilling of multi-holes in omega plate has been taken as a case study. The omega plate is used beneath the fifth wheel on the truck chassis. The figure 2 below shows the schematic diagram of the location of omega plate.

There are total 24 numbers of holes on the omega plate. All holes are of the same diameter (Ø18). The thickness of omega plate is 12mm. The cost per unit travel time (a) is PKR 250/m. The combined tool and machining costs when tool d is used on hole e (C_{de}) are identical for all operations (PKR. 330).

The holes number [3,4,5,8,9,10,15,16,17,20,21,22] are used to attach the semi trailer with fifth wheel and holes number [1,2,6,7,11,12,13,14,18,19,23,24] are used to attach the chassis with omega plate. The location of each hole and its relative distance has been shown in the figure 3 below as the side view and the top view.

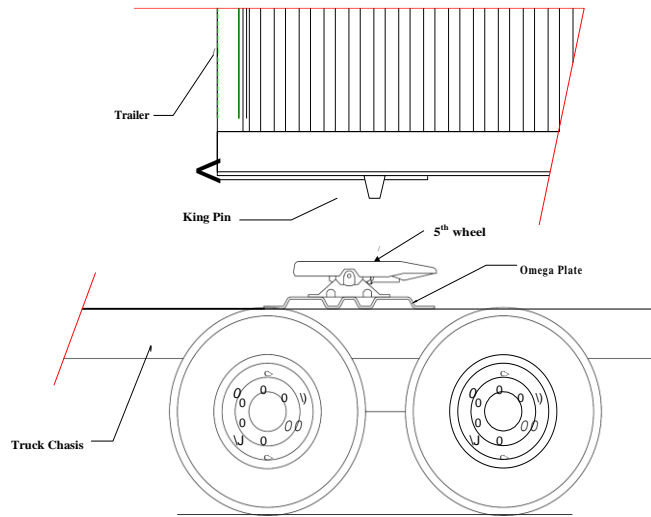

Figure. 2 Location of omega plate

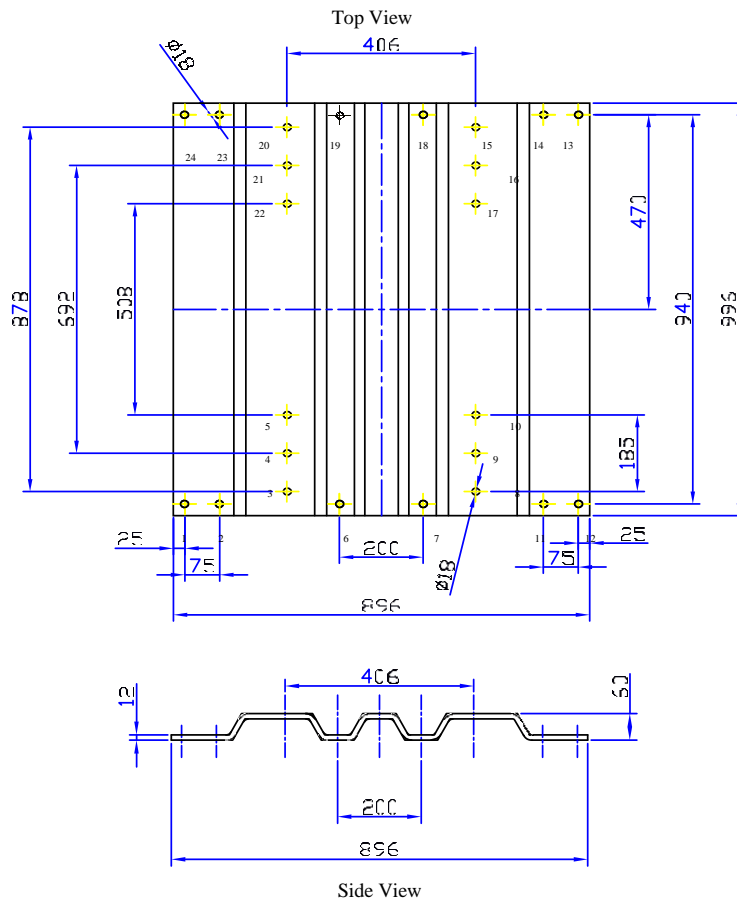

Figure. 3 Top and side view of omega plate

There are total 24 numbers of holes on the omega plate. All holes are of the same diameter ($\text{Ø}18$). The thickness of omega plate is 12mm. The cost per unit travel time (a) is PKR 250/m. The combined tool and machining costs when tool d is used on hole e (C_{ae}) are identical for all operations (PKR. 330). The holes number 3,4,5,8,9,10,15,16,17,20,21 and 22 are used to attach the semi trailer with fifth wheel and holes number 1,2,6,7,11,12,13,14,18,19,23 and 24 are used to attach the chassis with omega plate. The location of each hole and its relative distance has been shown in the figure 3 below as the sideview and the top view.

In this problem Euclidian distance has been used. The Euclidian distance matrix has been shown in the table 1 below

Table. 1 Distance matrix of omega plate

	1	2	3	4	5	6	7	8	9	10	11	12
1	0	75	222.17	252.53	308.31	323	523	626.76	638.16	662.21	771	846
2	75	0	148.27	190.79	260.15	248	448	551.87	564.78	591.82	696	771
3	222.17	148.27	0	93	185	107.5639	304.58	406	416.51	446.16	551.87	626.76
4	252.53	190.79	93	0	92	161.1986	327.39	416.51	406	416.29	564.78	638.16
5	308.31	260.15	185	92	0	239.3011	372.10	446.16	416.29	406	591.82	662.21
6	323	248	107.56	161.19	239.30	0	200	304.58	327.39	372.10	448	523
7	523	448	304.58	327.39	372.10	200	0	107.56	161.19	239.30	248	323
8	626.76	551.87	406	416.51	446.16	304.5817	107.56	0	93	185	148.27	222.17
9	638.16	564.78	416.51	406	416.29	327.3912	161.19	93	0	92	190.79	252.53
10	662.21	591.82	446.16	416.29	406	372.1089	239.30	185	92	0	260.15	308.31
11	771	696	551.87	564.78	591.82	448	248	148.27	190.79	260.15	0	75
12	846	771	626.76	638.16	662.21	523	323	222.17	252.53	308.31	75	0
13	1264.64	1215.74	1103.70	1028.46	957.10	1075.699	993.94	935.24	845.13	756.68	942.98	940
14	1215.74	1169.62	1062.95	984.61	909.82	1041.299	972.16	920.49	828.78	738.37	940	942.98
15	1103.70	1062.95	967.32	883.77	803.17	958.1701	914.81	878	785	693	920.49	935.24
16	1028.46	984.61	883.77	802.30	724.45	870.4395	822.47	785	692	600	828.78	845.13
17	957.10	909.82	803.17	724.45	650.30	784.8471	731.29	693	600	508	738.37	756.68
18	1075.69	1041.29	958.17	870.43	784.84	961.0411	940	914.81	822.47	731.29	972.16	993.94
19	993.94	972.16	914.81	822.47	731.29	940	961.04	958.17	870.43	784.84	1041.29	1075.69
20	935.24	920.49	878	785	693	914.8169	958.17	967.32	883.77	803.17	1062.95	1103.70
21	845.13	828.78	785	692	600	822.4749	870.43	883.77	802.30	724.45	984.61	1028.46
22	756.68	738.37	693	600	508	731.29	784.84	803.17	724.45	650.30	909.82	957.106
23	942.98	940	920.49	828.78	738.37	972.1646	1041.29	1062.95	984.61	909.82	1169.62	1215.74
24	940	942.98	935.24	845.13	756.68	993.9462	1075.69	1103.70	1028.46	957.10	1215.74	1264.64
	13	14	15	16	17	18	19	20	21	22	23	24
1	1264.64	1215.74	1103.70	1028.46	957.10	1075.69	993.94	935.24	845.13	756.68	942.98	940
2	1215.74	1169.62	1062.95	984.61	909.82	1041.29	972.16	920.49	828.78	738.37	940	942.98
3	1103.70	1062.95	967.32	883.77	803.17	958.17	914.81	878	785	693	920.49	935.24
4	1028.46	984.61	883.77	802.30	724.45	870.43	822.47	785	692	600	828.78	845.13

5	957.10	909.82	803.17	724.45	650.30	784.84	731.29	693	600	508	738.37	756.68
6	1075.69	1041.29	958.17	870.43	784.84	961.04	940	914.81	822.47	731.29	972.16	993.94
7	993.94	972.16	914.81	822.47	731.29	940	961.04	958.17	870.43	784.84	1041.29	1075.69
8	935.24	920.49	878	785	693	914.81	958.17	967.32	883.77	803.17	1062.95	1103.70
9	845.13	828.78	785	692	600	822.47	870.43	883.77	802.30	724.45	984.61	1028.46
10	756.68	738.37	693	600	508	731.29	784.84	803.17	724.45	650.30	909.82	957.10
11	942.98	940	920.49	828.78	738.37	972.16	1041.29	1062.95	984.61	909.82	1169.62	1215.74
12	940	942.98	935.24	845.13	756.68	993.94	1075.69	1103.70	1028.4	957.10	1215.74	1264.64
13	0	75	222.17	252.53	308.31	323	523	626.76	638.16	662.21	771	846
14	75	0	148.27	190.79	260.15	248	448	551.87	564.78	591.82	696	771
15	222.17	148.27	0	93	185	107.56	304.58	406	416.51	446.16	551.87	626.76
16	252.53	190.79	93	0	92	161.19	327.39	416.51	406	416.29	564.78	638.16
17	308.31	260.15	185	92	0	239.30	372.10	446.16	416.29	406	591.82	662.21
18	323	248	107.56	161.19	239.30	0	200	304.58	327.39	372.10	448	523
19	523	448	304.58	327.39	372.10	200	0	107.56	161.19	239.30	248	323
20	626.76	551.87	406	416.51	446.16	304.58	107.56	0	93	185	148.27	222.17
21	638.16	564.78	416.51	406	416.29	327.39	161.19	93	0	92	190.79	252.53
22	662.21	591.82	446.16	416.29	406	372.10	239.30	185	92	0	260.15	308.31
23	771	696	551.87	564.78	591.82	448	248	148.27	190.79	260.15	0	75
24	846	771	626.76	638.16	662.21	523	323	222.17	252.53	308.31	75	0

b. Formulation of problem and results obtained

The costs considered for optimization in drilling problems are the tool travel cost, tool switch cost, machining cost and tool cost. As the problem involves only one type of holes diameter, therefore tool switching costs are considered as zero. In this problem tool travel cost is optimized. The tool travel cost is incurred when the tool moves from its previous hole to the new hole for drilling. The tool travel cost is proportional to the tool traveling time between the holes. Euclidean distance between the holes is used in this study. The total tool travel time is when spindle traverses all the holes and comes to its starting hole. The tool travel time L_{de} when the spindle moves from the present hole location “d” to next hole location “e” can be calculated using the following equation, where x and y are the coordinates of holes d and e.

$$L_{de} = \sqrt{(|x_d - x_e|^2 + |y_d - y_e|^2)} \quad (5)$$

The proposed hybrid algorithm is coded in MATLAB. The results obtained are shown in the form of a convergence graph as Figure 4.

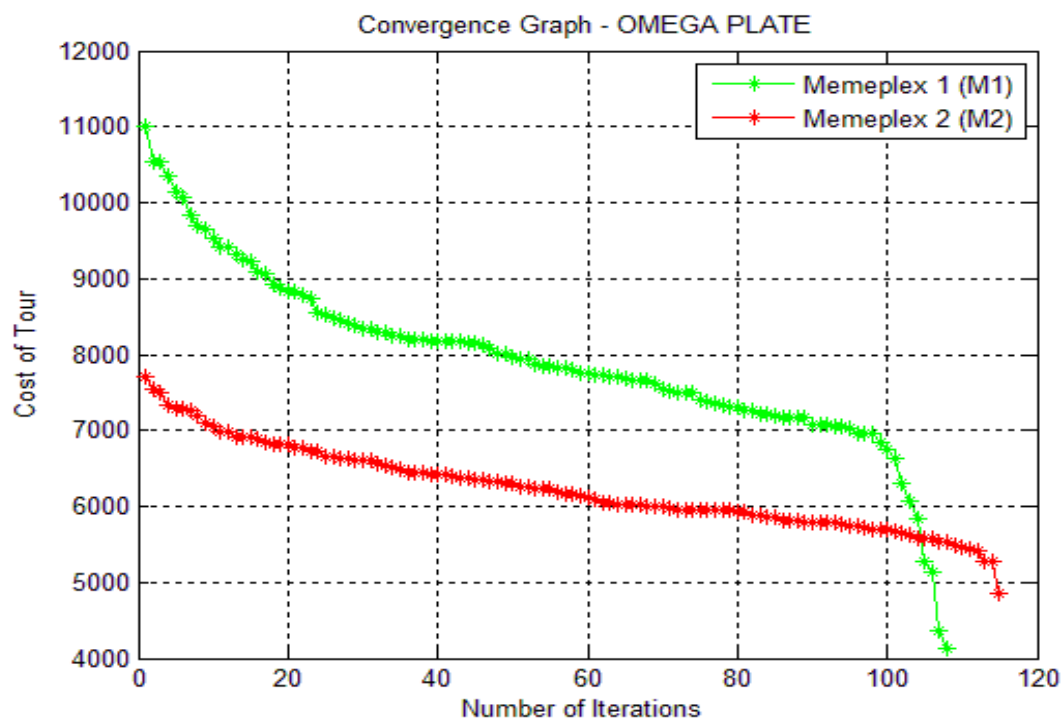
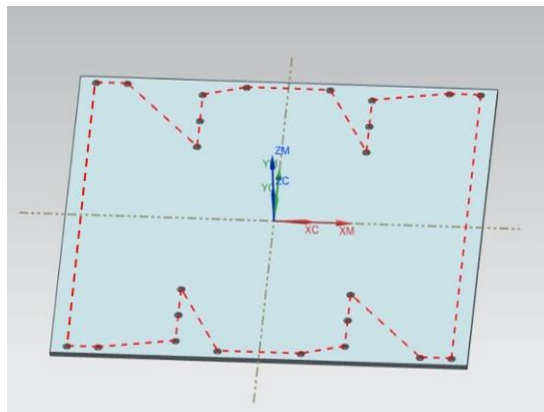

Figure 4. MATLAB graph of the results for Omega plate problem

In Figure 4, the x-axis and the y-axis indicate the number of iterations and the cost of the tours respectively. Two memplexes (M1 and M2) were used. In M1, the cost of the tour started at 11000mm and ended at 4117mm after a total of 108 iterations. In M2, the cost of the tour started at 7750mm and ended at 4900mm. The optimized cost of the tour for the omega plate problem is 4117mm and the optimal sequence by using proposed hybrid algorithm is [1,2,3,4,5,6,7,8,13,18,17,14,15,16,25,24,23,22,21,20,19,12,11,10,9, and 1], which has been obtained through memplex 2 (M2).

c. Comparison of results and discussion

The results of the hybrid algorithm are compared with those of manual method and commercially available software Creo 6.0 and Siemens NX. In manual method machinist uses his own choice of path selection and performs the drilling operation on manual machine. The paths obtained through manual method, Creo 6.0, Siemens NX, and proposed hybrid algorithm are shown in Figure 5 below.



5(a) Machinist path

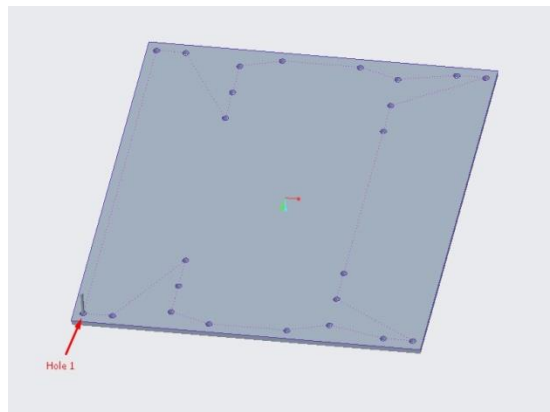

5(b) Creo 6.0 path

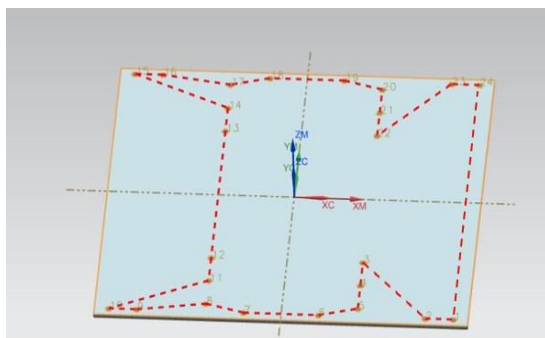

5(c) Siemen NX path

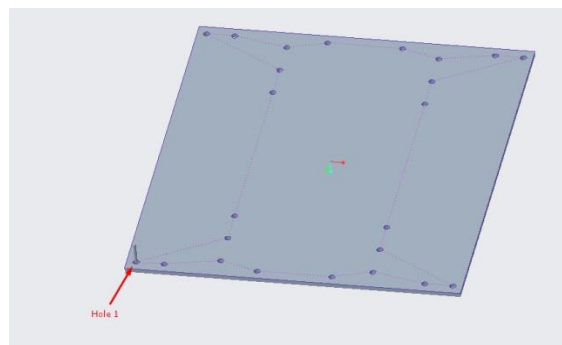

5(d) Proposed algorithm path

Table 2 presents a comparison of the performance with regard to machining and tooling cost , the traveling cost and the path sequence among machinist choice, Creo 6.0, Siemens NX, and the proposed hybrid algorithm.

Table 2. Comparison of results

Method	Optimal path	C_{de} (PKR)	l_{de} (mm)	$a \times l_{de}$ (PKR)	Total cost (PKR)
Manual Method (Machinist choice)	1,2,3,4,5,6,7,8,9,10,1 1,12,17,16,15,13,14,1 8,19,20,21,22,23,24,1	330	4790.84	$250 \times 4.79 = 1197.5$	1527.5
Creo 6.0	1,5,4,3,6,7,8,11,12,9, 10,17,16,13,14,15,18, 19,20,21,22,23,24,1	330	4454.14	$250 \times 4.45 = 1112.5$	1442.5 (5.7% less than manual)
Siemens NX	1,5,4,3,6,7,8,11,12,9, 10,17,16,13,14,15,18, 19,20,21,22,23,24,1	330	4454.14	$250 \times 4.45 = 1112.5$	1442.5 (5.7% less than manual)
Hybridized SFLA and ACO	1,2,3,6,7,8,11,12,9, 10,17,16,13,14,15,18, 19,20,23,24,21,22,5, 4,1	330	4117.40	$250 \times 4.11 = 1027.5$	1357.5 (11.1% less than manual and 5.9% less than Creo 6.0 and Siemens NX)

As shown in the table above, the tooling and machining cost for hole-making operations will remain the same as it was assumed in the beginning. The total nonproductive traveling by the spindle for the manual method, Creo 6.0, Siemens NX, and the proposed hybrid algorithm is 4790.84mm (4.79M), 4454.14mm (4.45M), 4454.14mm (4.45M), and 4117.4mm (4.11M) respectively. The corresponding cost of nonproductive traveling is PKR.1527.5, 1442.5, 1442.5, and 1357.5 respectively. This shows that the Creo 6.0 and Siemens NX design software improved the tool travel time by 5.7% compared with the manual method. The proposed hybrid algorithm improved the tool travel time by 11.1%, 5.9% and 5.9% compared with the manual method, Creo 6.0, and Siemens NX respectively. Hence,

the proposed hybrid algorithm outperformed the manual method, the Creo 6.0 and Siemens NX design software with regard to the total cost.

CONCLUSION

It can be concluded from the results that manual method, in which selection of path for drilling is with the machinist, is not the right choice as it is often not optimal. The results can be improved when commercially available software is used. But the results of commercially available software are not optimal all the time. This is evident from the results in the omega plate problem. It has been seen that by using Creo 6.0 and Siemens NX, the results are improved by 5.7% in comparison with results of manual method. The results of the Creo 6.0 and Siemens NX are not optimal in the omega plate problem and can be verified when proposed hybrid algorithm is used.

The results of the proposed hybrid algorithm are better than those of manual method, Creo 6.0, and Siemens NX. The proposed hybrid algorithm has improved the results of manual method, Creo 6.0, and Siemens NX by 11.1%, 5.9%, and 5.9% respectively. Thus, proposed hybrid algorithm has outperformed manual method, the Creo 6.0, and Siemens NX design software. The results of this study signify the use of metaheuristic approaches for optimization of drilling tool path. The results of this study encourage the applications of the proposed algorithm to complex drilling tool path optimization problems. Multi-hole drilling is required in many manufacturing industries. Therefore, industrial management should consider the employment of the metaheuristic algorithms for the optimization of drilling problems as it significantly reduces the manufacturing costs by reducing the overheads.

(Received February 2022, accepted March 2022)

REFERENCES

- [1] Merchant, M. E. (1985). World trends and prospects in manufacturing technology. *International Journal of Vehicle Design*, 6(2), 121-138.
<https://www.inderscienceonline.com/doi/abs/10.1504/IJVD.1985.061334>
- [2] Medina-Rodriguez, N., Montiel-Ross, O. (2012). Tool path optimization for computer numerical control machines based on parallel ACO. *Engineering Letters* 20(1):8.
- [3] Montiel-Ross, O., Medina-Rodríguez, N., Sepúlveda, R., Melin, P. (2012). Methodology to optimize manufacturing time for a CNC using a high performance implementation of ACO. *International Journal of Advanced Robotic Systems Syst* 9:1–10.
- [4] Nabeel, P. Abid, K, Abdulrazzaq HF. (2014). Tool path optimization of drilling sequence in CNC machine using genetic algorithm. *Innovative Systems Design and Engineering* 5(1):15–26
- [5] Pezer, D. (2016). Efficiency of Tool path optimization using genetic algorithm in relation to the optimization achieved with CAM software. *International conference of manufacturing engineering and materials* :374-379
- [6] Nguyen, T.T., Pham, H.T., Nguyen, T.H. (2017). Tool path optimization in CNC punching machine for sheet metal manufacturing. *International conference on system science and engineering*. 381-386
- [7] Saravanan, M. (2018). Tool Path optimization by Genetic algorithm for Energy Efficient Machining. *www.tagajournals.com* vol. 14
- [8] Garcia, H.R., Romero J.S., Gomis, H.M., Rao, R.V. (2020) Parallel implementation of metaheuristics for optimizing tool path computation on CNC machining. *Computers in Industry*.
- [9] Khatiwada, D., Nepali, N., Chaulagain, R., Bhattarai A. (2020). Tool path optimization for drilling holes using genetic algorithm. *International journal of machine tools and maintenance engineering*. 1(1),36-42
- [10] Eusuff, M. M., Lansey, K.E., Pasha, F. (2006). Shuffled frog leaping algorithm: a memetic metaheuristic for discrete optimization. *Eng.Optim.*,38(2)129-54.
- [11] Luo, X. H, Y, Li X. (2008). Solving TSP with shuffled frog leaping algorithm. *Proc. ISDA*;3:228-232
- [12] Luo, Ping LU, Qinang, WU, Chenxi. (2001). Modified shuffled frog leaping algorithm based on new searching strategy. In: *Proceeding of the 7th international conference on natural computation*.
- [13] Roy, P, Pritam, Roy, Chakarwari A. (2013). Modified shuffled frog leaping algorithm with genetic algorithm crossover for solving economic load dispatch problem with valve point effect. *Appl. Soft Compt*;13;4244-52
- [14] Niknam, T., Nrimani, M.R., Jabbari, M., Malekpour, A.R. (2011).A modified shuffled frog leaping algorithm for multi objective optimal power flow. *Energy*.;36;6420-32.

- [15] Elbeltagi, E., Track, H., Donald, G. (2007). A modified shuffled frog leaping optimization algorithm application to project management. *Struct. Infrastruct. Eng.*;3(1)53-60
- [16] Marco, D., Thomas, S.. (2004). Ant colony optimization, 1st edition, The MIT Press, London.
- [17] Nasir, M., Nasir, M., Umer, and Ahmad, R. (2013). A Survey of Recent Developments for JSSP and FJSSP Using ACO. *Advanced Materials Research* 816–817: 1133–39.